

REMORQUE SPEED FEET 19
=> SCHEMAS REELS SUIVANT FERS DISPONIBLES
VUE DE COTE
SYSTEME DE BUTEE ARRIERE
=> FREINAGE REMORQUE
=> PROTECTION SAFRANS

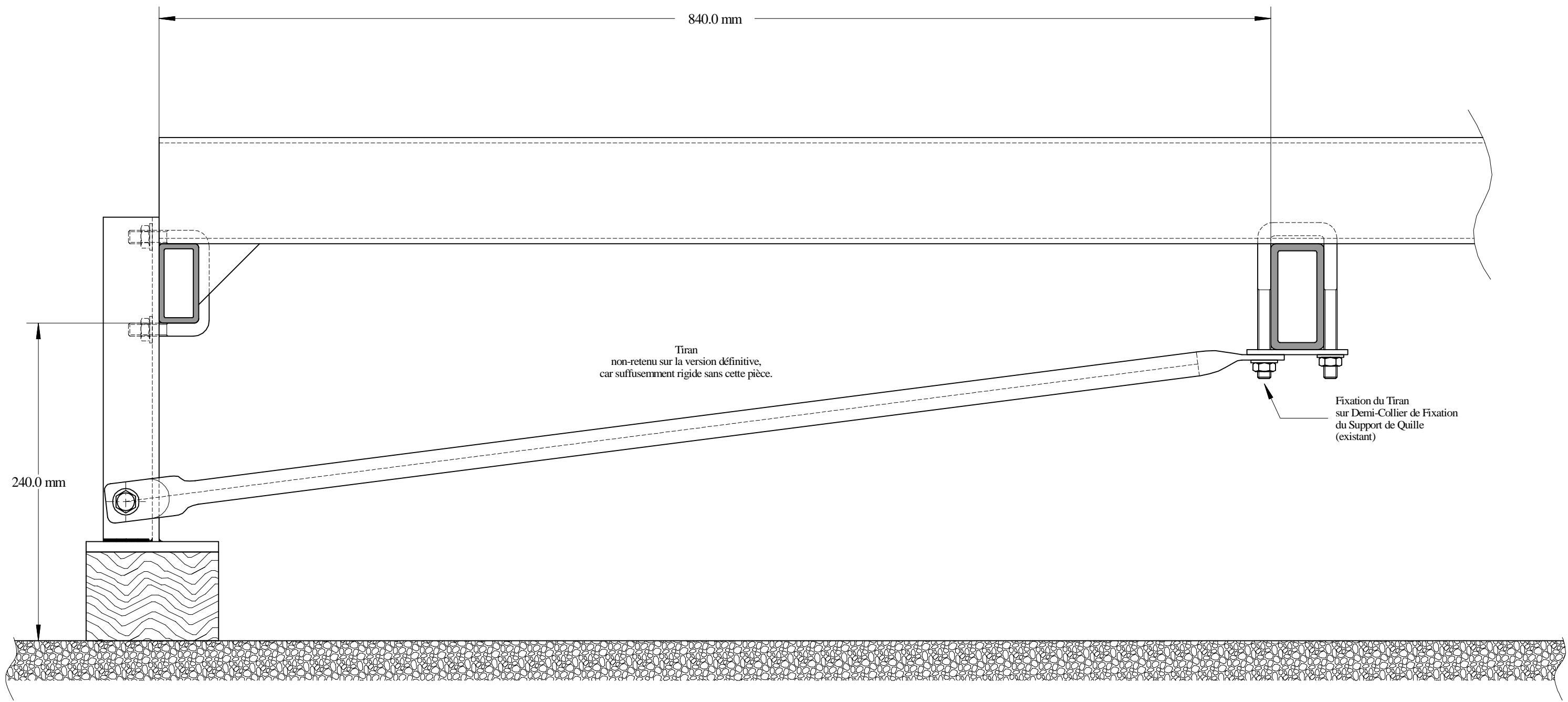

VUE DES TIRANS, REPRIS SUR LES FIXATIONS DES
DEMI-COLLIER DE LA PLAQUE SUPOPORTANT LA QUILLE

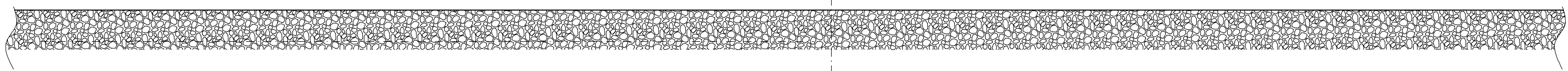
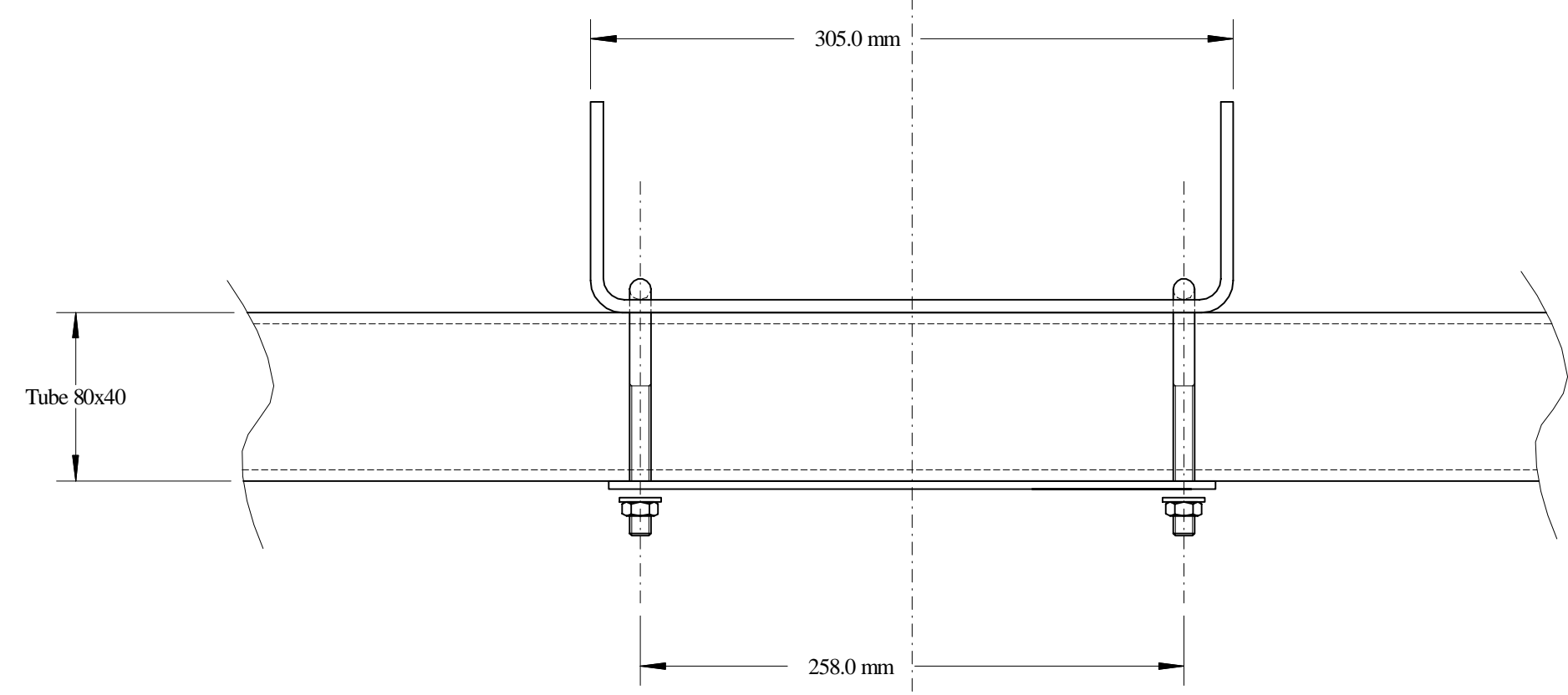

VUE ARRIERE
BUTEE ARRIERE, BOIS A MARTIR 70x70

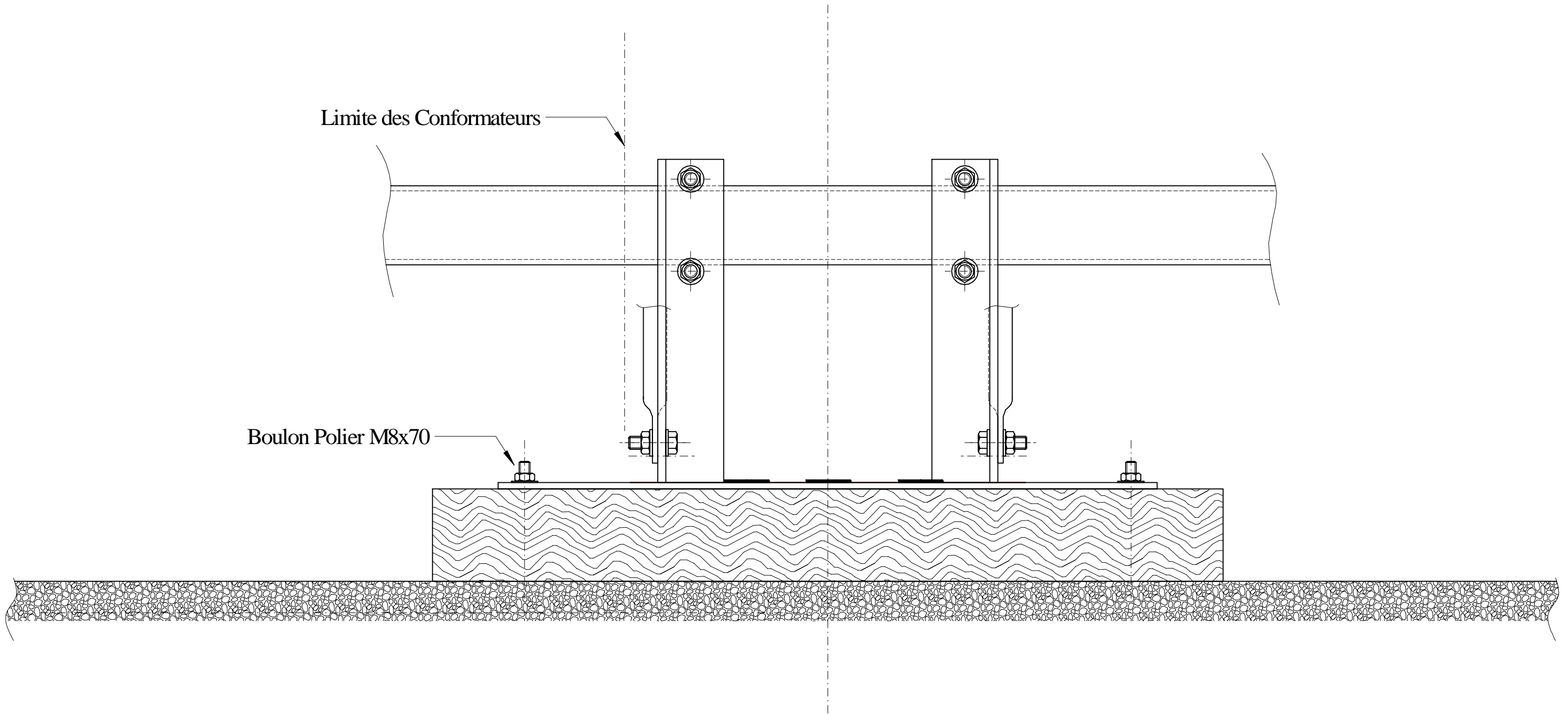

COTATIONS...

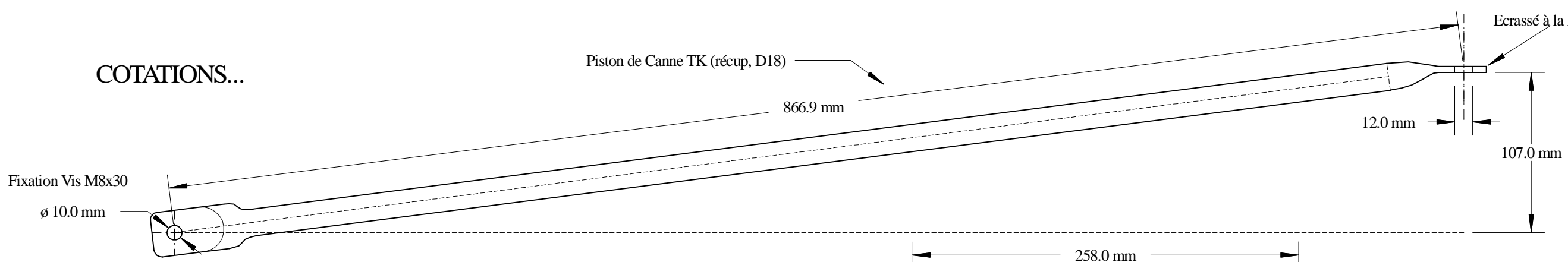

04/04
 F. Combet
 Remorque Speed Feet 18
 Modification Butés-Arrière
 de Freinage et Protection Safrans

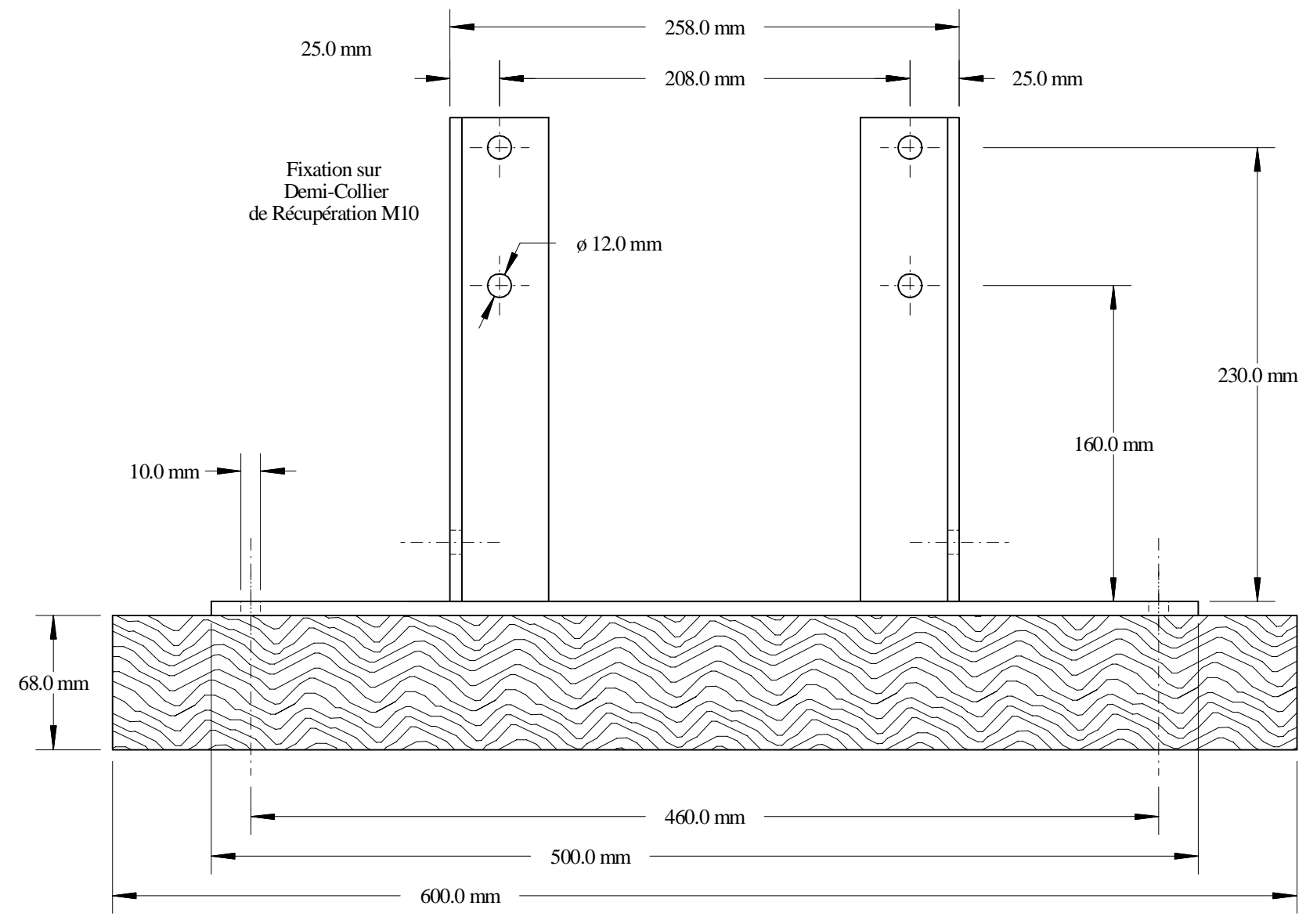
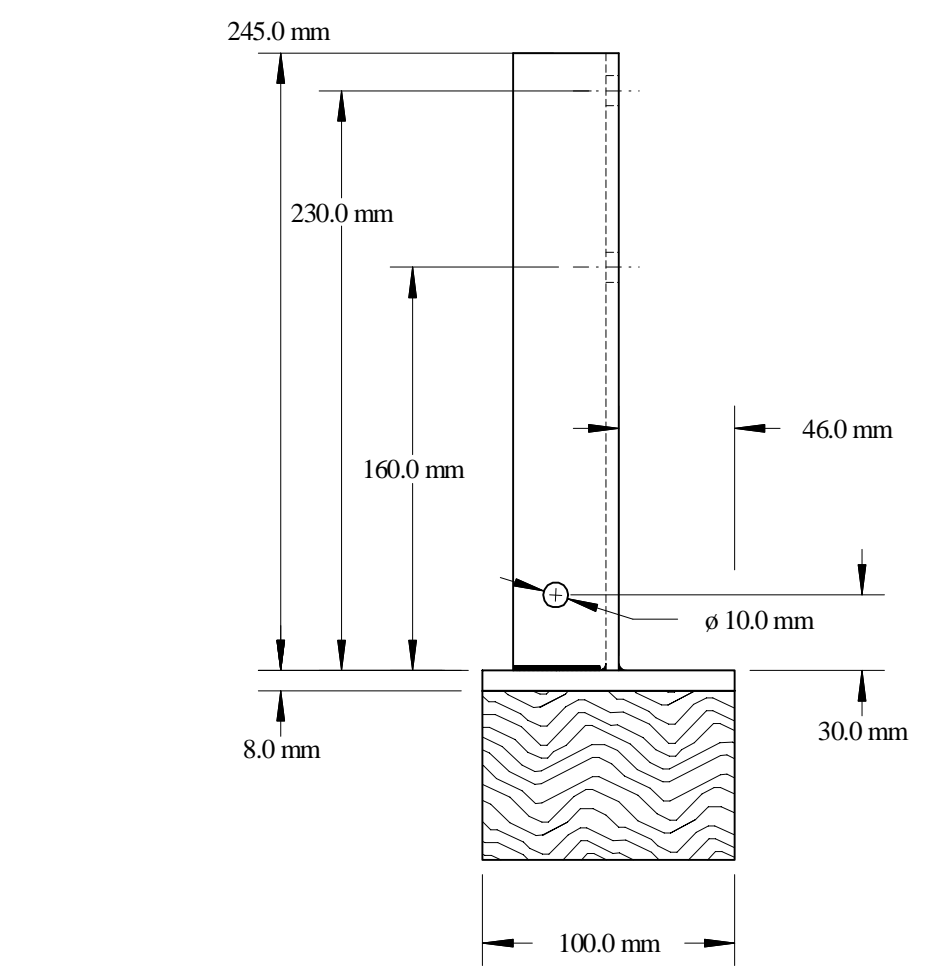

Fixation du Bois Martyr
 par Vis BTR M8x70

